

Window Options



Ruston Heritage



Sunray x 8 Heritage



Sunray 2 x 4 Heritage



Sherwood 4 x 2 Heritage



Stockton Heritage



Ventilation



Plain Heritage



Ruston Ranch



Sunray x 4 Ranch



Sunray 2 x 2 Ranch



Sherwood Ranch



Stockton Ranch



Stockford Ranch



Plain Ranch

For that extra special finishing touch, create a striking entrance to your home with a window feature. For garages prone to dampness, ventilated window options are also available. Your local Steel-Line expert will be more than happy to discuss the full range of window options available to you.



Technical Details

In placing an order you will be required to submit the following information.

Description	Measurements
Opening Size Height LHS	
Opening Size Height RHS	
Opening Size Width	
Side Room LHS	
Side Room RHS	
Headroom	

Example: 2130mm opening height will require a 2160mm high door.

Door Size Width	Opening size + minimum 25mm / side
Door Size Height	Opening size + 30mm for the height
Side Room Minimum	125mm standard and 150mm for low headroom
Headroom Minimum	Standard 290mm Low headroom - front mount 200mm Low headroom - rear mount 150mm
When Using An Operator	Add 50mm to the minimum headroom required

Please note: The above table is a guide only and some dimensions may change.

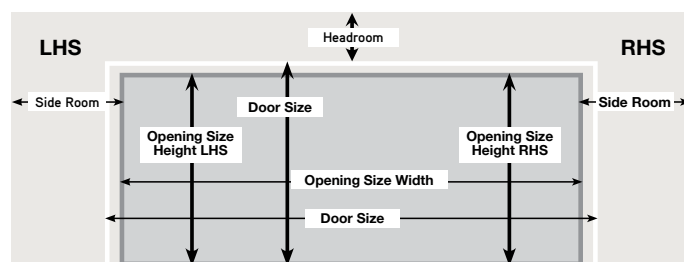

(View from inside of garage, looking out)



Quality Features That Will Stand The Test Of Time

For many years Steel-Line's range of garage doors has set the benchmark for style and quality throughout the Australian garage door industry.

Most Steel-Line sectional garage doors can be automated for ease of use. As a market leader in safety and innovation, all of Steel-Line's automatic garage door openers come with a range of safety features. The standard 'Auto Reverse System' causes the garage door to immediately stop and reverse when it comes into contact with an object, while the optional 'Photo Eye' feature automatically reverses the closing garage door if its electronic beam senses an obstruction. Furthermore, to ensure smoothness of operation and one of the quietest garage door mechanisms available, Steel-Line uses specially designed composite nylon and steel hinges.

FingerProof™ Safety

Steel-Line's sectional garage doors feature a curved finger proof joint for added safety. This unique award-winning design not only safeguards your family against serious injury, it seals out elements that can penetrate conventional garage doors.

Heavy Duty Bottom Rail

Every Steel-Line sectional garage door is fitted with a sturdy heavy duty bottom rail to increase strength in the lower part of the garage door. A tough and durable weather seal is added to the bottom rail for extra protection from the elements.

Strong and Quiet Operation

To avoid the harsh sounds of metal-on-metal, Steel-Line uses hinges made of specially designed composite materials such as nylon for smooth, quiet and trouble free operation.

Proudly distributed by:

ZBROSLV8 (0519) Copyright © Steel-Line Garage Door Australia. All rights reserved.



FingerProof™ Safety Feature



Heavy Duty Bottom Rail



Strong and Quiet Hinges



Call 1300 427 243 | steel-line.com.au

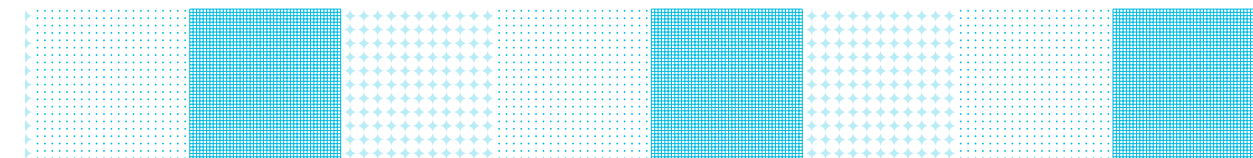

makers
for life



If you're ready to draw the line at average and reach for better call us today.

To locate Steel-Line branches across Australia call: **1300 427 243** or visit steel-line.com.au

Sectional Garage Doors

Enhance the exterior of your home with a garage door that will complement any style of architecture. Steel-Line has a range of garage door styles to suit the unique characteristics of your home. Choose from the stylish Heritage, Ranch, Slimline, Glacier or Flatline door styles and then select the finish of your choice to really dress up and enhance the exterior of your home.

Make a bold impression with a stunning Steel-Line sectional garage door.

Your garage door is possibly the largest exterior feature of your home so the right colour and finish treatment are essential. In addition to the full range of Dulux® Powdercoat and Colorbond® colours, Steel-Line also offers a unique range of DecoWood® timber finishes allowing you to match your garage door to other external finishes.

Steel-Line's sectional garage doors have exceptional weather-resistant qualities. They are resilient against wind and dust conditions and come with tough PVC weather seals and heavy duty aluminium bottom rails, so you can trust that the precious contents of your garage are protected at all times.



3 easy steps to create your sectional garage door

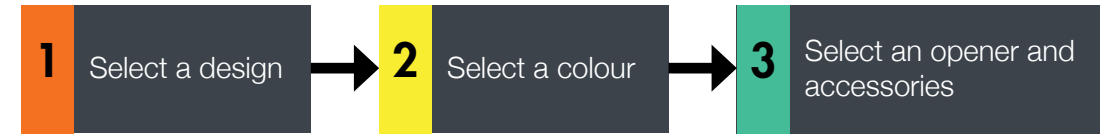

1 Door Profiles and Finishes

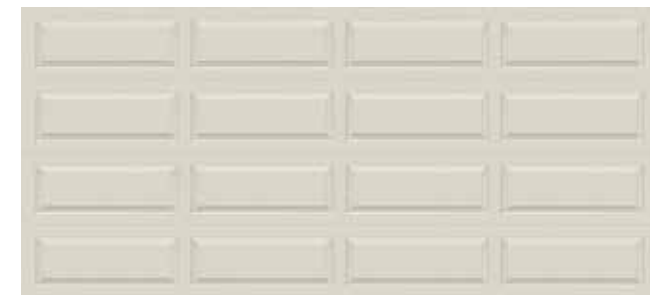

Ranch (textured finish)

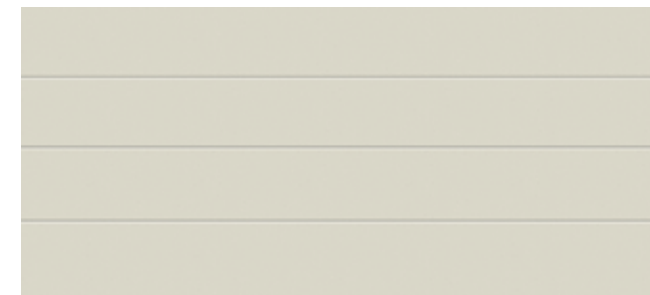

Flatline (textured finish)



Glacier (smooth or textured finish)



Textured Finish | Slimline

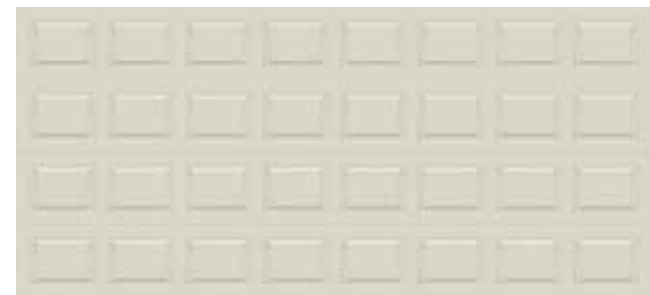

Heritage (textured finish)

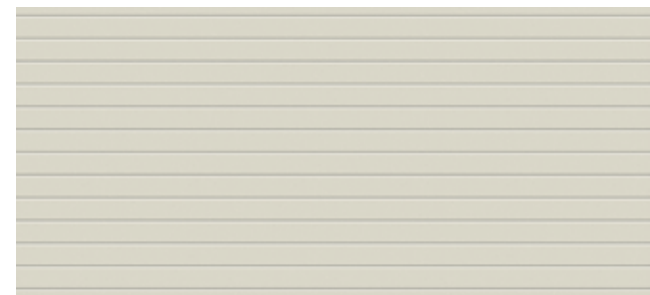

Slimline (smooth or textured finish)

NOTE:

- Windows can only be fitted to Ranch or Heritage profiles in standard Colorbond® colours. For more details, please see the back page.
- Smooth finish is available in the Savannah range at premium pricing.
- For "smooth finish" garage doors, shadowing in the panel surface will be more evident. Shadowing is the rippling that occurs as a result of roll forming / pressing flat sheet steel.



Smooth Finish | Glacier

2 Colour Options

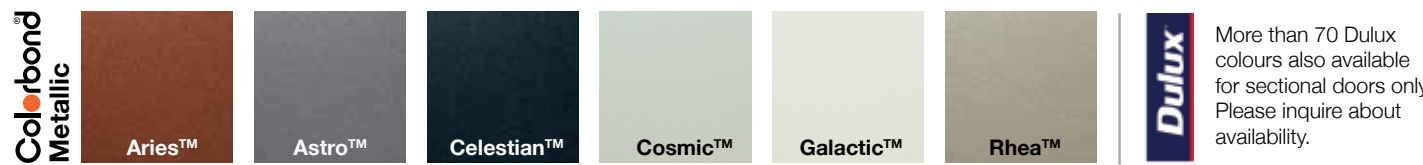
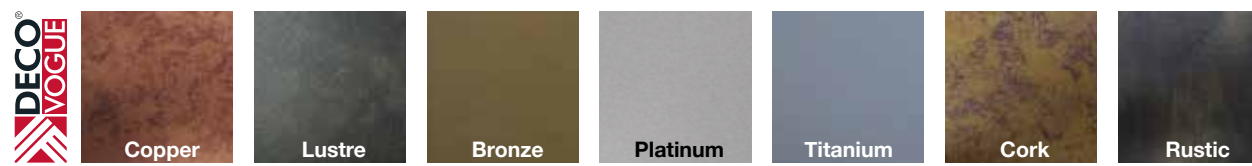
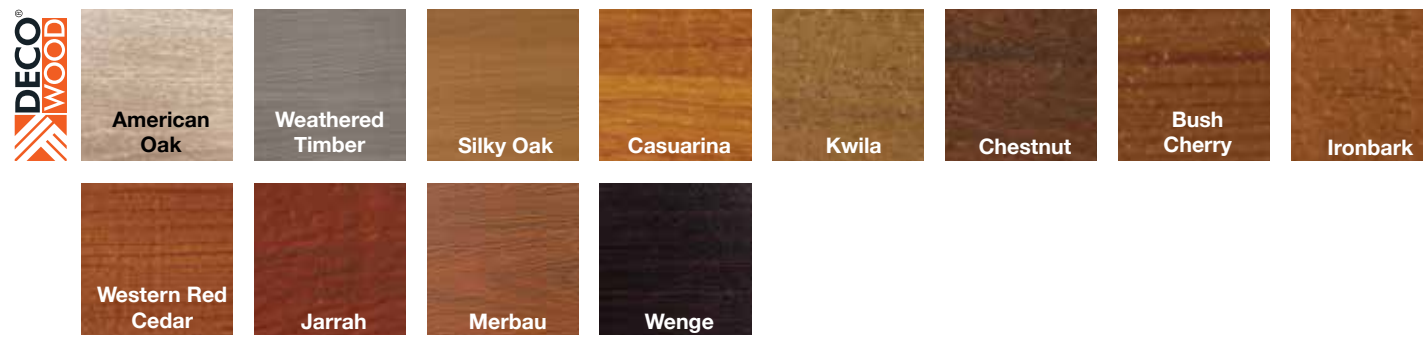

NOTE:

- All colours shown on this chart are a guide only. The limitations of printing processes make extremely accurate matches impossible. We strongly recommend comparing your choice with actual samples. Additionally, Steel-Line reserves the right to vary or remove colours without notice.
- Rendered range and Colorbond Metallic range are only available in smooth finish and in the Slimline and Glacier sectional door profiles.
- Premium colours are not available in smooth finish.

3 A small additional investment for greater convenience

Fit your Steel-Line sectional garage door with an automatic opener for hassle free entry to and exit from your garage.

All of our openers are engineered to the highest standards ensuring easy operation, optimum performance, long life and peace of mind.

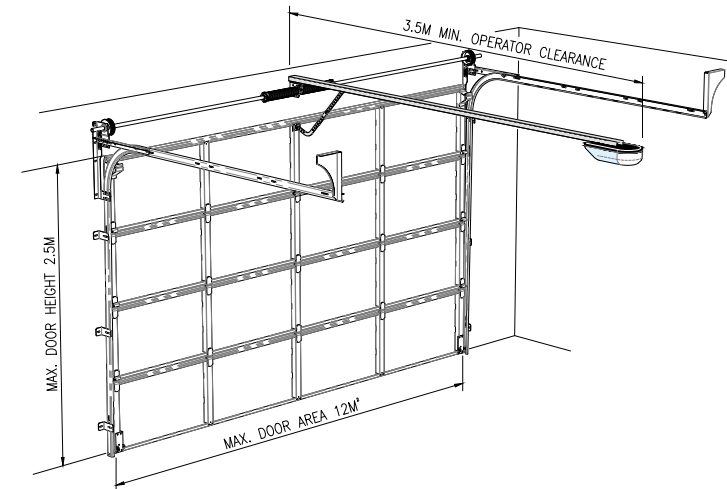

“Some things we can't control, others you just don't have to.”

Soft Start and Stop Function

This feature is designed to allow for a quiet and smooth garage door operation, which is important when the garage is located close to bedrooms or living areas.

Auto Reverse System

For added safety, each installation comes with this automated feature that causes the garage door to immediately stop and reverse when it comes into contact with an object.

Auto Sensing Force

During operation the force required is constantly monitored and adjusted to ensure economical operation and reduced wear and tear.

Courtesy Light

This courtesy light is the most convenient way to navigate through your garage and to get in and out of your car. The light automatically switches on and off as you open and close your garage door.

Wireless Wall Button

Can be installed near an internal access door to your garage giving you greater convenience to open and close your garage door.



Digital Limit System

Equipped with digital limit system for ease of programming during installation.

Manual Release

In case of power failure you can simply activate the manual release to open your garage door.

Remote Handsets

The key ring remote handsets are small and convenient with the ability to operate up to four garage doors or gates from the one unit. A must have for every set of keys in the house.



Quality and Adaptability

Our garage door openers are manufactured from quality composite materials, and have been engineered to the highest standard. They can also be fitted to most popular brands of sectional garage doors with accessories to suit your requirements.